

Pioneer

DJ Controller

DDJ-SX

serato || **serato**  **DJ**

<http://pioneerdj.com/support/>

The Pioneer DJ support site shown above offers FAQs, information on software and various other types of information and services to allow you to use your product in greater comfort.

<http://serato.com/>

For the latest version of the Serato DJ software, access Serato.com and download the software from there.

Read Before Use (Important)/Quick Start Guide

Thank you for buying this Pioneer product. Please read through these operating instructions so you will know how to operate your model properly. After you have finished reading the instructions, put them away in a safe place for future reference. In some countries or regions, the shape of the power plug and power outlet may sometimes differ from that shown in the explanatory drawings. However the method of connecting and operating the unit is the same.

IMPORTANT



The lightning flash with arrowhead symbol, within an equilateral triangle, is intended to alert the user to the presence of uninsulated "dangerous voltage" within the product's enclosure that may be of sufficient magnitude to constitute a risk of electric shock to persons.

CAUTION

**RISK OF ELECTRIC SHOCK
DO NOT OPEN**

CAUTION:
TO PREVENT THE RISK OF ELECTRIC SHOCK, DO NOT REMOVE COVER (OR BACK). NO USER-SERVICEABLE PARTS INSIDE. REFER SERVICING TO QUALIFIED SERVICE PERSONNEL.



The exclamation point within an equilateral triangle is intended to alert the user to the presence of important operating and maintenance (servicing) instructions in the literature accompanying the appliance.

D3-4-2-1-1_A1_En

IMPORTANT SAFETY INSTRUCTIONS

- 1) Read these instructions.
- 2) Keep these instructions.
- 3) Heed all warnings.
- 4) Follow all instructions.
- 5) Do not use this apparatus near water.
- 6) Clean only with dry cloth.
- 7) Do not block any ventilation openings. Install in accordance with the manufacturer's instructions.
- 8) Do not install near any heat sources such as radiators, heat registers, stoves, or other apparatus (including amplifiers) that produce heat.
- 9) Do not defeat the safety purpose of the polarized or grounding-type plug. A polarized plug has two blades with one wider than the other. A grounding type plug has two blades and a third grounding prong. The wide blade or the third prong are provided for your safety. If the provided plug does not fit into your outlet, consult an electrician for replacement of the obsolete outlet.
- 10) Protect the power cord from being walked on or pinched particularly at plugs, convenience receptacles, and the point where they exit from the apparatus.
- 11) Only use attachments/accessories specified by the manufacturer.
- 12) Use only with the cart, stand, tripod, bracket, or table specified by the manufacturer, or sold with the apparatus. When a cart is used, use caution when moving the cart/apparatus combination to avoid injury from tip-over.
- 13) Unplug this apparatus during lightning storms or when unused for long periods of time.
- 14) Refer all servicing to qualified service personnel. Servicing is required when the apparatus has been damaged in any way, such as power-supply cord or plug is damaged, liquid has been spilled or objects have fallen into the apparatus, the apparatus has been exposed to rain or moisture, does not operate normally, or has been dropped.



D3-7-13-69_En

FEDERAL COMMUNICATIONS COMMISSION DECLARATION OF CONFORMITY

This device complies with part 15 of the FCC Rules. Operation is subject to the following two conditions: (1) This device may not cause harmful interference, and (2) this device must accept any interference received, including interference that may cause undesired operation.

Product Name: DJ Controller

Model Number: DDJ-SX

Responsible Party Name: PIONEER ELECTRONICS (USA) INC.
SERVICE SUPPORT DIVISION

Address: 1925 E. DOMINGUEZ ST. LONG BEACH, CA 90810-1003, U.S.A.

Phone: 1-800-421-1404

URL: <http://www.pioneerelectronics.com>

D8-10-4* _C1_En

WARNING

This equipment is not waterproof. To prevent a fire or shock hazard, do not place any container filled with liquid near this equipment (such as a vase or flower pot) or expose it to dripping, splashing, rain or moisture.

D3-4-2-1-3_A1_En

WARNING

Before plugging in for the first time, read the following section carefully.

The voltage of the available power supply differs according to country or region. Be sure that the power supply voltage of the area where this unit will be used meets the required voltage (e.g., 230 V or 120 V) written on the AC adapter's label.

D3-4-2-1-4*_A1_En

WARNING

To prevent a fire hazard, do not place any naked flame sources (such as a lighted candle) on the equipment.

D3-4-2-1-7a_A1_En

Operating Environment

Operating environment temperature and humidity:
+5 °C to +35 °C (+41 °F to +95 °F); less than 85 %RH
(cooling vents not blocked)

Do not install this unit in a poorly ventilated area, or in locations exposed to high humidity or direct sunlight (or strong artificial light)

D3-4-2-1-7c*_A1_En

If the AC plug of this unit does not match the AC outlet you want to use, the plug must be removed and appropriate one fitted. Replacement and mounting of an AC plug on the power supply cord of this unit should be performed only by qualified service personnel. If connected to an AC outlet, the cut-off plug can cause severe electrical shock. Make sure it is properly disposed of after removal. The equipment should be disconnected by removing the mains plug from the wall socket when left unused for a long period of time (for example, when on vacation).

D3-4-2-2-1a_A1_En

When using this product, confirm the safety information shown on the bottom of the unit.

D3-4-2-2-4_B1_En

NOTE

THE NO USER-SERVICEABLE PARTS COMPARTMENT WARNING IS LOCATED ON THE APPLIANCE BOTTOM.

D3-7-13-68_A1_En

Information to User

Alterations or modifications carried out without appropriate authorization may invalidate the user's right to operate the equipment.

D8-10-2_A1_En

CAUTION

This product satisfies FCC regulations when shielded cables (with Ferrite-cores attached) and connectors are used to connect the unit to other equipment. To prevent electromagnetic interference with electric appliances such as radios and televisions, use shielded cables (with Ferrite-cores attached) and connectors for connections.

D8-10-3b_A1_En

WARNING

Store small parts out of the reach of children and infants. If accidentally swallowed, contact a doctor immediately.

D41-6-4_A1_En

This product is for general household purposes. Any failure due to use for other than household purposes (such as long-term use for business purposes in a restaurant or use in a car or ship) and which requires repair will be charged for even during the warranty period.

K041_A1_En

CAUTION

The **STANDBY/ON** switch on this unit will not completely shut off all power from the AC outlet. Since the power cord serves as the main disconnect device for the unit, you will need to unplug it from the AC outlet to shut down all power. Therefore, make sure the unit has been installed so that the power cord can be easily unplugged from the AC outlet in case of an accident. To avoid fire hazard, the power cord should also be unplugged from the AC outlet when left unused for a long period of time (for example, when on vacation).

D3-4-2-2-2a*_A1_En

POWER-CORD CAUTION

Handle the power cord by the plug. Do not pull out the plug by tugging the cord and never touch the power cord when your hands are wet as this could cause a short circuit or electric shock. Do not place the unit, a piece of furniture, etc., on the power cord, or pinch the cord. Never make a knot in the cord or tie it with other cords. The power cords should be routed such that they are not likely to be stepped on. A damaged power cord can cause a fire or give you an electrical shock. Check the power cord once in a while. When you find it damaged, ask your nearest PIONEER authorized service center or your dealer for a replacement.

S002*_A1_En

IMPORTANT NOTICE

THE MODEL NUMBER AND SERIAL NUMBER OF THIS EQUIPMENT ARE ON THE REAR OR BOTTOM. RECORD THESE NUMBERS ON PAGE 21 FOR FUTURE REFERENCE.

D36-AP9-1_A1_En_PSV

WARNING: Handling the cord on this product or cords associated with accessories sold with the product may expose you to chemicals listed on proposition 65 known to the State of California and other governmental entities to cause cancer and birth defect or other reproductive harm.
Wash hands after handling.

D36-P5_B1_En

This Class B digital apparatus complies with Canadian ICES-003.

D8-10-1-3_A1_En

NOTE:

This equipment has been tested and found to comply with the limits for a Class B digital device, pursuant to Part 15 of the FCC Rules. These limits are designed to provide reasonable protection against harmful interference in a residential installation. This equipment generates, uses, and can radiate radio frequency energy and, if not installed and used in accordance with the instructions, may cause harmful interference to radio communications. However, there is no guarantee that interference will not occur in a particular installation. If this equipment does cause harmful interference to radio or television reception, which can be determined by turning the equipment off and on, the user is encouraged to try to correct the interference by one or more of the following measures:

- Reorient or relocate the receiving antenna.
- Increase the separation between the equipment and receiver.
- Connect the equipment into an outlet on a circuit different from that to which the receiver is connected.
- Consult the dealer or an experienced radio/TV technician for help.

D8-10-1-2_A1_En

The Safety of Your Ears is in Your Hands

Get the most out of your equipment by playing it at a safe level – a level that lets the sound come through clearly without annoying blaring or distortion and, most importantly, without affecting your sensitive hearing. Sound can be deceiving. Over time, your hearing “comfort level” adapts to higher volumes of sound, so what sounds “normal” can actually be loud and harmful to your hearing. Guard against this by setting your equipment at a safe level BEFORE your hearing adapts.

ESTABLISH A SAFE LEVEL:

- Set your volume control at a low setting.
- Slowly increase the sound until you can hear it comfortably and clearly, without distortion.
- Once you have established a comfortable sound level, set the dial and leave it there.

BE SURE TO OBSERVE THE FOLLOWING GUIDELINES:

- Do not turn up the volume so high that you can't hear what's around you.
- Use caution or temporarily discontinue use in potentially hazardous situations.
- Do not use headphones while operating a motorized vehicle; the use of headphones may create a traffic hazard and is illegal in many areas.

S001a_A1_En

Contents

How to read this manual

- Thank you for buying this Pioneer product.
Be sure to read both this leaflet and the operating instructions! Both documents include important information that you must understand before using this product.
For instructions on acquiring the operating instructions, see *Acquiring the manual* (p. 16).
- In this manual, names of screens and menus displayed on the product and on the computer screen, as well as names of buttons and terminals, etc., are indicated within brackets. (e.g.: [CUE] button, [Files] panel, [VINYL] mode, [AUX IN] terminal)
- Please note that the screens and specifications of the software described in this manual as well as the external appearance and specifications of the hardware are currently under development and may differ from the final specifications.
- Please note that depending on the operating system version, web browser settings, etc., operation may differ from the procedures described in this manual.
- In some countries or regions, the shape of the power plug and power outlet may sometimes differ from that shown in the explanatory drawings. However the method of connecting and operating the unit is the same.

01 Before start

What's in the box	6
Installing the software	6

02 Operation

Connections	9
Starting the system	11
Quitting the system	14
Names of Parts	14

03 Acquiring the manual

Downloading this unit's operating instructions	16
Downloading the Serato DJ software manual	16

04 About the AC adapter

Safety instructions	17
Mounting the power plug	18

05 Additional information

Troubleshooting	19
About trademarks and registered trademarks	20
Cautions on copyrights	20
Specifications	20

Before start

What's in the box

- CD-ROM (Installation Disc)
- AC adapter
- Power plug
- USB cable
- Read Before Use (Important)/Quick Start Guide (this document)

Installing the software

Before installing the software

For the latest version of the Serato DJ software, access Serato.com and download the software from there. A software download link is also provided on the included CD-ROM.

- For details, refer to "Installation Procedure (Windows)" or "Installation procedure (Mac OS X)".
- The user is responsible for preparing the computer, network devices and other elements of the Internet usage environment required for a connection to the Internet.

About the driver software (Windows)

This driver software is an exclusive ASIO driver for outputting audio signals from the computer.

- There is no need to install the driver software when using Mac OS X.

Checking the latest information on the driver software

For detailed information on this unit's designated driver software, see the Pioneer DJ support site below.
<http://pioneerdj.com/support/>

About the Serato DJ software

Serato DJ is a DJ software application by Serato. DJ performances are possible by connecting the computer on which this software is installed to this unit.

Minimum operating environment

Supported operating systems

Mac OS X: 10.6.8 and 10.7.4

Windows: Windows 7

Others

Optical drive	Optical disc drive on which the CD-ROM can be read
USB port	A USB 2.0 port is required to connect the computer with this unit.
Display resolution	Resolution of 1 280 x 720 or greater
Internet connection	An Internet connection is required for registering the "Serato.com" user account and downloading the software.

- For the latest information on the required operating environment and compatibility as well as to acquire the latest operating system, refer to "Software Info" under "DDJ-SX" on the Pioneer DJ support site below.
<http://pioneerdj.com/support/>
- Operation is not guaranteed on all computers, even if all the required operating environment conditions indicated here are fulfilled.
- Depending on the computer's power-saving settings, etc., the CPU and hard disk may not provide sufficient processing capabilities. For notebook computers in particular, make sure the computer is in the proper conditions to provide constant high performance (for example by keeping the AC power connected) when using Serato DJ.

- Use of the Internet requires a separate contract with a provider offering Internet services and payment of provider fees.

About the installation procedure

The installation procedure depends on the operating system (OS) on the computer you are using.

For Windows

After installing the driver software, install the Serato DJ software.

For Mac OS X

Only install the Serato DJ software.

Installation Procedure (Windows)

Do not connect this unit and the computer until installation is completed.

- Log on as the user which was set as the computer's administrator before installing.
- If any other programs are running on the computer, quit them.

1 Insert the CD-ROM into the computer's optical drive.

The CD-ROM menu is displayed.

- If the CD-ROM menu does not appear when the CD-ROM is inserted, open the optical drive from [Computer (or My Computer)] in the [Start] menu, then double-click the [CD_menu.exe] icon.

2 When the CD-ROM menu appears, select [Install Driver Software (Pioneer_DDJ_SX_Driver_x.xxx.exe)], then click [Start].

- To close the CD-ROM menu, click [Exit].

3 Proceed with installation according to the instructions on the screen.

If [Windows Security] appears on the screen while the installation is in progress, click [Install this driver software anyway] and continue with the installation.

When the installation program is completed, a completion message appears.

After installing the driver software, install the Serato DJ software.

4 Select [Install DJ Software (Serato DJ/Download)] from the CD-ROM's menu, then click [Start].

5 "An internet environment is required to access the site. Connected to the internet?" is displayed. Click [Yes].

The web browser is launched and the Pioneer DJ support site is displayed.

6 Click [Software Info] under [DDJ-SX] on the Pioneer DJ support site.

[Serato DJ Support Information] is displayed.

7 Click the link to the Serato DJ download page.

The Serato DJ download page is displayed.

8 Log in to your "Serato.com" user account.

- If you have already registered a user account on "Serato.com", proceed to step 10.
- If you have not completed registering your user account, do so following the procedure below.
 - Following the instructions on the screen, input your e-mail address and the password you want to set, then select the region in which you live.
 - If you check [E-mail me Serato newsletters], newsletters providing the latest information on Serato products will be sent from Serato.

- Once user account registration is completed, you will receive an e-mail at the e-mail address you have input. Check the contents of the e-mail sent from "Serato.com".
- Be careful not to forget the e-mail address and password specified when you performed user registration. They will be required for updating the software.
- The personal information input when registering a new user account may be collected, processed and used based on the privacy policy on the Serato website.

9 Click the link in the e-mail message sent from "Serato.com".

This takes you to the Serato DJ download page. Proceed to step 11.

10 Log in.

Input the e-mail address and password you have registered to log in to "Serato.com".

11 Download the Serato DJ software from the download page.

Unzip the downloaded file, then double-click the unzipped file to launch the installer.

12 Read the terms of the license agreement carefully, and if you agree, select [I agree to the license terms and conditions], then click [Install].



- If you do not agree to the contents of the usage agreement, click [Close] to cancel installation. Installation begins.



The message of successful installation appears once installation is completed.

13 Click [Close] to quit the Serato DJ installer.

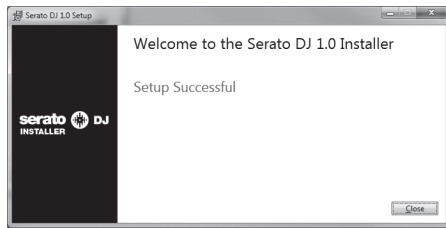

Installation procedure (Mac OS X)

Do not connect this unit and the computer until installation is completed.

- If any other programs are running on the computer, quit them.

1 Insert the CD-ROM into the computer's optical drive.

The CD-ROM menu is displayed.

- If the CD-ROM menu does not appear on the screen when the CD-ROM is inserted, open the optical driver from Finder, then double-click the [CD_menu.app] icon.

2 Select [Install DJ Software (Serato DJ/Download)] from the CD-ROM's menu, then click [Start].

3 "An internet environment is required to access the site. Connected to the internet?" is displayed. Click [Yes].

The web browser is launched and the Pioneer DJ support site is displayed.

4 Click [Software Info] under [DDJ-SX] on the Pioneer DJ support site.

[Serato DJ Support Information] is displayed.

5 Click the link to the Serato DJ download page.

The Serato DJ download page is displayed.

6 Log in to your "Serato.com" user account.

- If you have already registered a user account on "Serato.com", proceed to step 8.
- If you have not completed registering your user account, do so following the procedure below.
 - Following the instructions on the screen, input your e-mail address and the password you want to set, then select the region in which you live.
 - If you check [E-mail me Serato newsletters], newsletters providing the latest information on Serato products will be sent from Serato.
 - Once user account registration is completed, you will receive an e-mail at the e-mail address you have input. Check the contents of the e-mail sent from "Serato.com".
- Be careful not to forget the e-mail address and password specified when you performed user registration. They will be required for updating the software.
- The personal information input when registering a new user account may be collected, processed and used based on the privacy policy on the Serato website.

7 Click the link in the e-mail message sent from "Serato.com".

This takes you to the Serato DJ download page. Proceed to step 9.

8 Log in.

Input the e-mail address and password you have registered to log in to "Serato.com".

9 Download the Serato DJ software from the download page.

Unzip the downloaded file, then double-click the unzipped file to launch the installer.

10 Read the terms of the license agreement carefully, and if you agree, click [Agree].

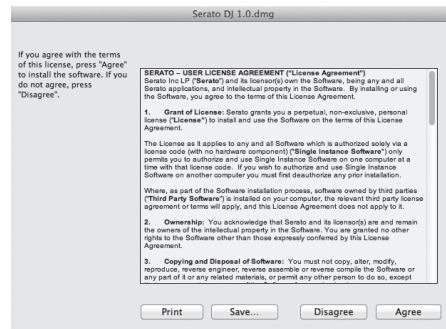

- If you do not agree to the contents of the usage agreement, click [Disagree] to cancel installation.

11 If the following screen appears, drag and drop the [Serato DJ] icon on the [Applications] folder icon.



Operation

- Wait until all connections between devices have been completed before connecting the AC adapter. Be sure to turn off the power and unplug the AC adapter from the power outlet before making or changing connections between devices. Refer to the operating instructions for the component to be connected.
- Only use the AC adapter included with this unit.
- Power is supplied to this unit by the AC adapter.
- Connect this unit and the computer directly using the included USB cable.
- A USB hub cannot be used.

CAUTION

Due to the product's specifications, the display may be turned off completely by operating switches on the main unit or remote controller (if included) so that the product may appear the same as when the AC adapter is unplugged from the power outlet, but power is still being supplied. To completely isolate the product from the power supply, the AC adapter (shutoff device) must be unplugged from the power outlet. Install the product near an outlet with the AC adapter (shutoff device) within easy reach, and when not using the product for long periods of time, such as when traveling, unplug the AC adapter from the power outlet. Failure to do so may cause fires.

2 Connect powered speakers, a power amplifier, components, etc., to the [MASTER OUT 1] or [MASTER OUT 2] terminals.

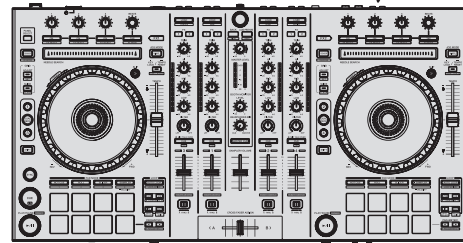
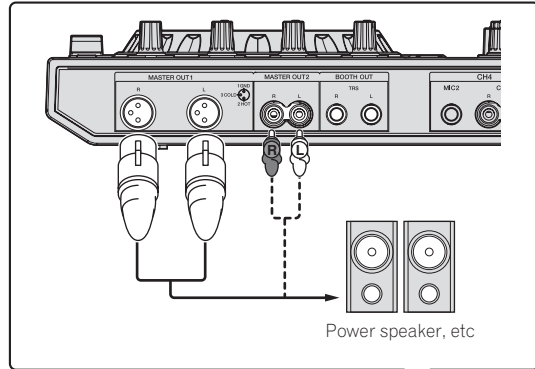

- To output the sound from the [BOOTH] terminals, connect speakers or other devices to the [BOOTH] terminals.
- For details on connecting the input/output terminals, see the Operating Instructions.

Connections

1 Connect headphones to one of the [PHONES] terminals.

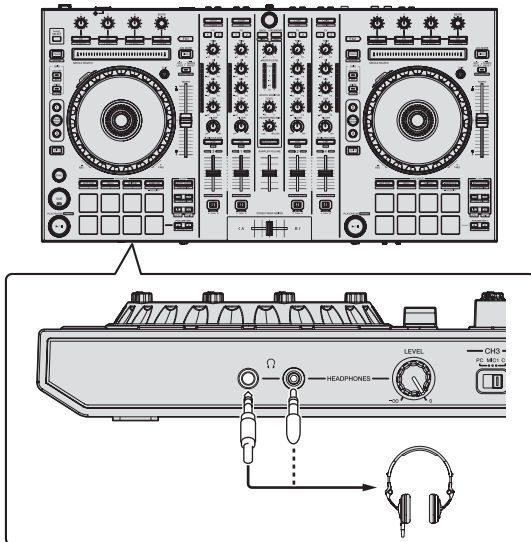

3 Connect this unit to your computer via a USB cable.

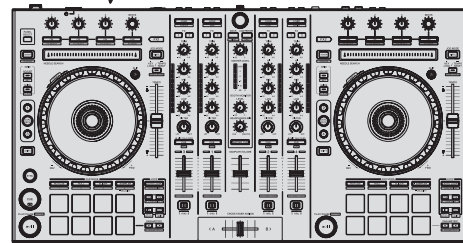
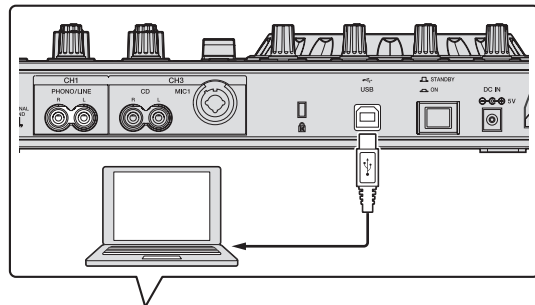

4 Turn on the computer's power.

5 Connect the power plug to the AC adapter.

Slide the power plug into the AC adapter's guide rails as shown on the diagram and press in until a click is heard.

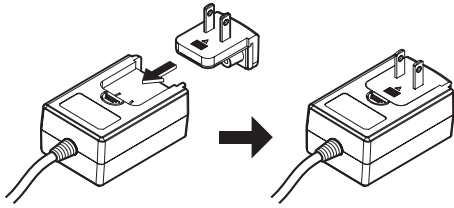

- For detailed cautions on the AC adapter, see “About the AC adapter” (p. 17).
- The shape of the plug differs according to the region in which the unit is sold.

6 Connect the AC adapter.

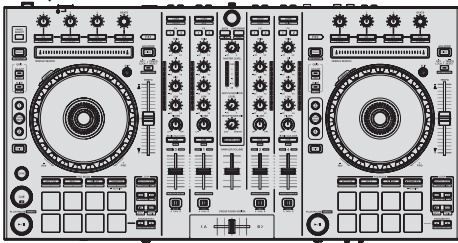
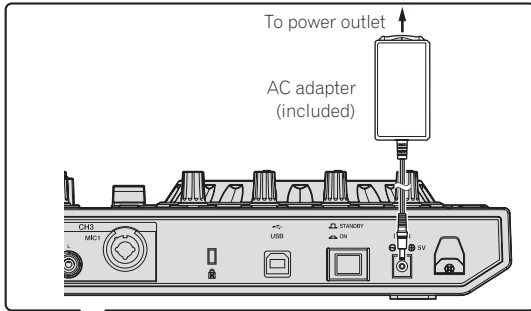

7 Press the [STANDBY/ON] switch on this unit's rear panel to turn this unit's power on.

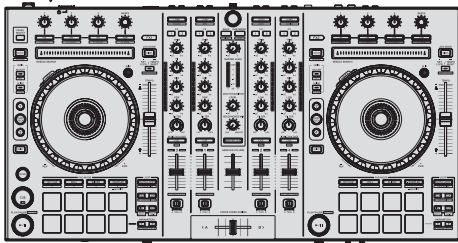
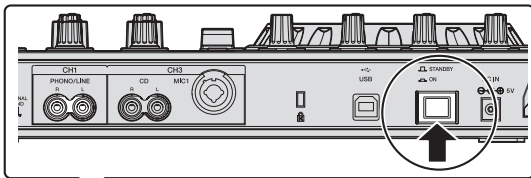

Turn on the power of this unit.

- For Windows users
The message **[Installing device driver software]** may appear when this unit is first connected to the computer or when it is connected to a different USB port on the computer. Wait a while until the message **[Your devices are ready for use]** appears.

8 Turn on the power of the devices connected to the output terminals (powered speakers, power amplifier, components, etc.).

- When a microphone, DJ player or other external device is connected to input terminals, the power of that device also turns on.

Starting the system

Launching Serato DJ

For Windows

From the Windows [Start] menu, click the [Serato DJ] icon under [All Programs] > [Serato] > [Serato DJ].

For Mac OS X

In Finder, open the [Application] folder, then click the [Serato DJ] icon.

Computer screen directly after the Serato DJ software is launched

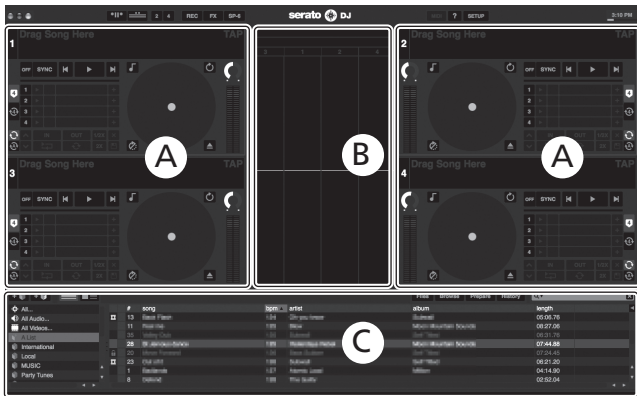

Computer screen when a track is loaded in the Serato DJ software

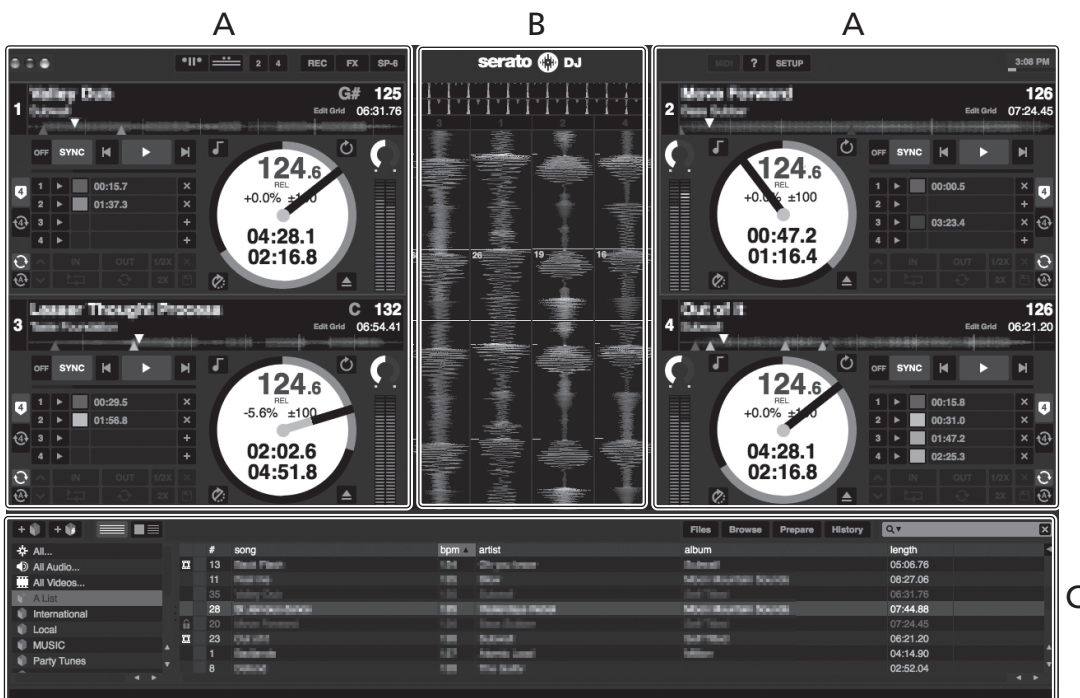

A Deck section

The track information (the name of the loaded track, artist name, BPM, etc.), the overall waveform and other information is displayed here.

B Waveform display

The loaded track's waveform is displayed here.

C Browser section

Crates in which tracks in the library or sets of multiple tracks are stored are displayed here.

This manual consists mainly of explanations of functions of this unit as hardware. For detailed instructions on operating the Serato DJ software, see the Serato DJ software manual.

2 Press the rotary selector, move the cursor to the library on the computer's screen, then turn the rotary selector and select the track.



a

b

- a Library
- b Crates panel

3 Press the [LOAD] button to load the selected track onto the deck.

Playing tracks and outputting the sound

The following describes the procedure for outputting the channel 1 sound as an example.

- Set the volume of the devices (power amplifier, powered speakers, etc.) connected to the [MASTER OUT 1] and [MASTER OUT 2] terminals to an appropriate level. Note that loud sound will be output if the volume is set too high.

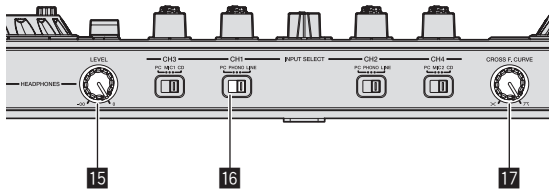
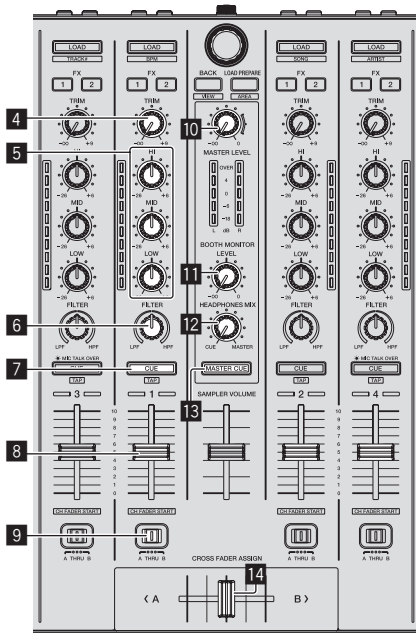

- 4 TRIM control
- 5 EQ (HI, MID, LOW) controls
- 6 FILTER control
- 7 Headphones CUE button
- 8 Channel fader
- 9 Crossfader Assign Switch
- 10 MASTER LEVEL control
- 11 BOOTH MONITOR LEVEL control
- 12 HEADPHONES MIXING control
- 13 MASTER CUE button
- 14 Crossfader
- 15 HEADPHONES LEVEL control
- 16 INPUT SELECT switch
- 17 Crossfader curve selector switch

1 Set the positions of the controls, etc., as shown below.

Names of controls, etc.	Position
MASTER LEVEL control	Turned fully counterclockwise
TRIM control	Turned fully counterclockwise
EQ (HI, MID, LOW) controls	Center
FILTER control	Center
Channel fader	Moved forward
Crossfader Assign Switch	[THRU] position
INPUT SELECT switch	[PC] position

2 Press the [▶/||] button to play the track.

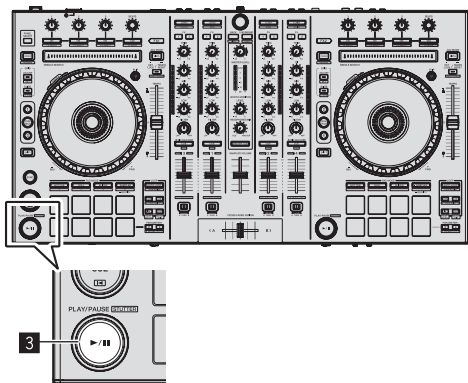

3 Move the channel fader away from you.

4 Turn the [TRIM] control.

Adjust [TRIM] so that the orange indicator on the channel level indicator lights at the peak level.

5 Turn the [MASTER LEVEL] control to adjust the audio level of the speakers.

Adjust the sound level output from the [MASTER OUT 1] and [MASTER OUT 2] terminals to an appropriate level.

Monitoring sound with headphones

Set the positions of the controls, etc., as shown below.

Names of controls, etc.	Position
HEADPHONES MIXING control	Center
HEADPHONES LEVEL control	Turned fully counterclockwise

1 Press the headphones [CUE] button for the channel 1.

2 Turn the [HEADPHONES LEVEL] control.

Adjust the sound level output from the headphones to an appropriate level.



Note

This unit and the Serato DJ software include a variety of functions enabling individualistic DJ performances. For details on the respective functions, see the operating instructions and the Serato DJ software manual.

- This unit's operating instructions can be downloaded from the Pioneer DJ support site. For details, see *Downloading this unit's operating instructions* (p. 16).
- The Serato DJ software manual can be downloaded from "Serato.com". For details, see *Downloading the Serato DJ software manual* (p. 16).

Quitting the system

1 Quit [Serato DJ].

When the software is closed, a message for confirming that you want to close it appears on the computer's screen. Click [Yes] to close.

2 Press the [STANDBY/ON] switch on this unit's rear panel to turn this unit's power off.

3 Disconnect the USB cable from your computer.

Names of Parts

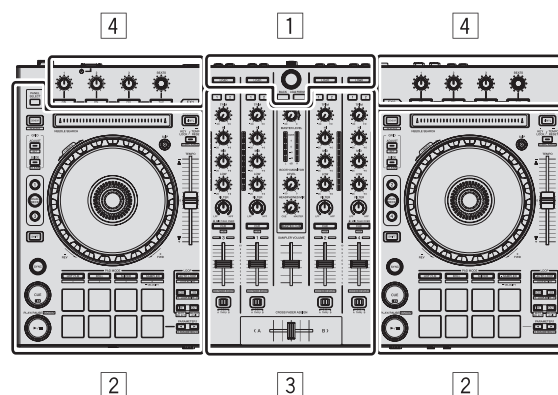

1 Browser section

2 Deck section

3 Mixer section

4 Effect section

Browser section

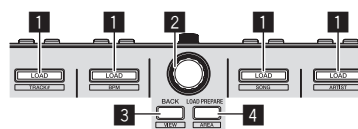

1 LOAD button

2 Rotary selector

3 BACK button

4 LOAD PREPARE button

Deck section

This section is used to control the four decks. The buttons and controls for operating decks 1 and 3 are located on the left side of the controller, those for operating decks 2 and 4 are located on the right side of the controller.

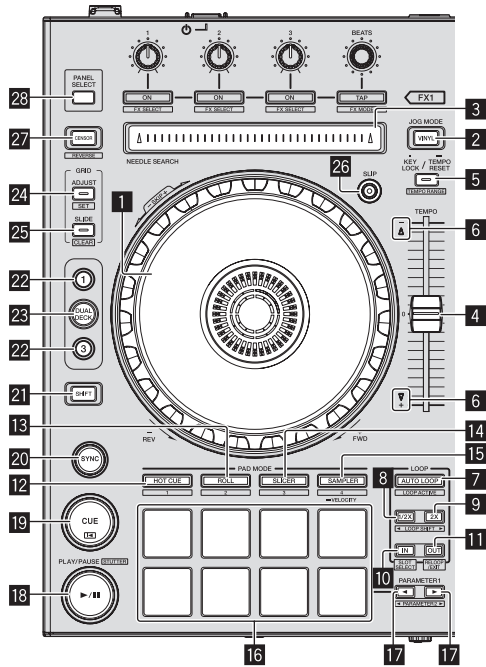

- 1 Jog dial
- 2 VINYL button
- 3 NEEDLE SEARCH pad
- 4 TEMPO slider
- 5 KEY LOCK button
- 6 TAKEOVER indicator
- 7 AUTO LOOP button
- 8 Half loop button
- 9 Double loop button
- 10 LOOP IN button
- 11 LOOP OUT button
- 12 HOT CUE mode button
- 13 ROLL mode button
- 14 SLICER mode button
- 15 SAMPLER mode button
- 16 Performance pads
- 17 PRAMETER1/2 button
- 18 PLAY/PAUSE ►/|| button
- 19 CUE button
- 20 SYNC button
- 21 SHIFT button
- 22 DECK button
- 23 DUAL DECK button
- 24 GRID ADJUST button
- 25 GRID SLIDE button
- 26 SLIP button
- 27 CENSOR button
- 28 PANEL SELECT button

Mixer section

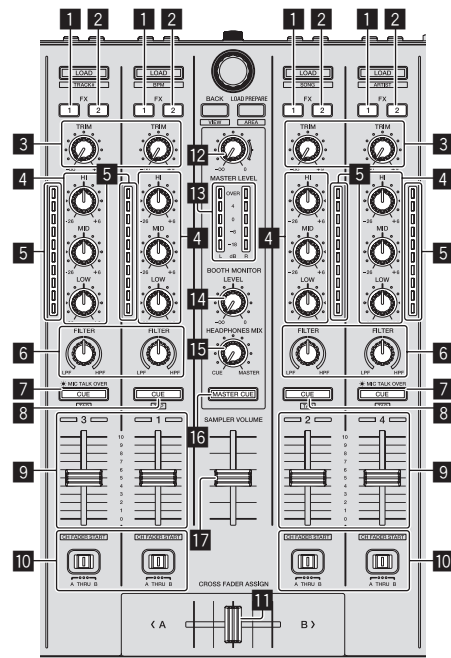

- 1 FX 1 assign button
- 2 FX 2 assign button
- 3 TRIM control
- 4 EQ (HI, MID, LOW) controls
- 5 Channel Level Indicator
- 6 FILTER control
- 7 Headphones CUE/MIC TALK OVER button
- 8 Headphones CUE button
- 9 Channel fader
- 10 Crossfader Assign Switch
- 11 Crossfader
- 12 MASTER LEVEL control
- 13 Master level indicator
- 14 Booth monitor level control
- 15 HEADPHONES MIXING control
- 16 MASTER CUE button
- 17 SAMPLER VOLUME fader

Operation

Effect section

This section is used to control the two effect units (FX1 and FX2). Controls and buttons to operate the FX1 unit are located on the left side of the controller, those to operate the FX2 unit are located on the right side of the controller. The channels to which the effect is to be applied are set using the effect assign buttons.

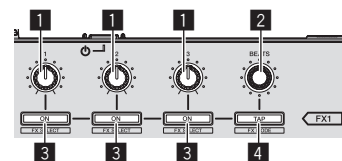

- 1 Effect parameter controls
- 2 FX BEATS control
- 3 Effect parameter buttons
- 4 TAP button

Acquiring the manual

The operating instructions may be in a file in PDF format. Adobe® Reader® must be installed to read files in PDF format. If you do not have Adobe Reader, please install it from the download link on the CD-ROM's menu screen.

Downloading this unit's operating instructions

1 Insert the CD-ROM into the computer's optical drive.

The CD-ROM menu is displayed.

If the CD-ROM's menu does not appear when the CD-ROM is inserted, perform the operations below.

- For Windows
Open the optical drive from [Computer (or My Computer)] in the [Start] menu, then double-click the [CD_menu.exe] icon.
- For Mac OS X
In Finder, double-click the [CD_menu.app] icon directly.

2 When the CD-ROM's menu is displayed, select [DDJ-SX: Operating Instructions (PDF file/Download)], then click [Start].

3 "An internet environment is required to access the site. Connected to the internet?" is displayed. Click [Yes].

The web browser is launched and the Pioneer DJ support site is displayed.

4 On the Pioneer DJ support site, click "Manuals" under "DDJ-SX".

5 Click on the required language on the download page.

Downloading of the operating instructions begins.

Downloading the Serato DJ software manual

1 Insert the CD-ROM into the computer's optical drive.

The CD-ROM menu is displayed.

If the CD-ROM's menu does not appear when the CD-ROM is inserted, perform the operations below.

- For Windows
Open the optical drive from [Computer (or My Computer)] in the [Start] menu, then double-click the [CD_menu.exe] icon.
- For Mac OS X
In Finder, double-click the [CD_menu.app] icon directly.

2 When the CD-ROM's menu is displayed, select [Serato DJ: Software Manual (PDF file/Download)], then click [Start].

3 "An internet environment is required to access the site. Connected to the internet?" is displayed. Click [Yes].

The web browser is launched and the Pioneer DJ support site is displayed.

- To close the CD-ROM menu, click [Exit].

4 Click [Software Info] under [DDJ-SX] on the Pioneer DJ support site.

[Serato DJ Support Information] is displayed.

5 Click the link to the Serato DJ download page.

The Serato DJ download page is displayed.

6 Log in to your "Serato.com" user account.

Input the e-mail address and password you have registered to log in to "Serato.com".

7 From "More Downloads" on the right side of the download page, click "Serato DJ x.x User Manual".

Downloading of the Serato DJ software manual starts.

About the AC adapter

Safety instructions

To ensure your personal safety and to maximize the full operating potential of your unit, read and follow these safety instructions.

Read & Retain Instructions

Read all operating and user information provided with this product.

Cleaning

Use a damp cloth to clean the exterior housing. Avoid using any fluids including liquid, aerosol or alcohol-based cleaning products.

Water or Moisture

Avoid operating or locating this product near water or other sources of fluid.

Accessories

Do not place this product on an unstable cart, stand, or table. The product may fall and be seriously damaged.

Ventilation

Do not block or cover this product in use. This unit should not be placed in a built-in installation unless properly ventilated.

Environment

Avoid placing this product in a location with exposure to large quantities of dust, high temperatures, high humidity, or subject to excessive vibrations or shocks.

Power Sources

Operate this product only from the recommended power sources. If you are unsure of the power source, consult an authorized Pioneer representative.

Power-Cord Protection

When unplugging the unit, pull on the plug – not on the cord. Do not handle the cord or plug with wet hands; doing so could cause an electric short or shock. Do not allow anything to pinch or rest on the power cord and do not place in a walkway.

Power

Turn OFF the system before installing this or any other hardware device.

Overloading

Avoid connecting too many devices to a single wall socket or power source as this can cause fires or short circuits.

Object & Liquid Entry

Never push inappropriate objects in to the device. Avoid spilling any liquids in to or on the outside of the drive.

Servicing

Opening or removing the cover exposes you to possible electrical shock or other danger. Contact a Pioneer authorized service representative for repairing this product (refer to the enclosed Service & Support Card).

Damage Requiring Service

Unplug the unit and refer servicing to qualified service personnel in the following situations:

- When the power cord, plug, or chassis is damaged.
- If liquid has been spilled, or objects have fallen into the product.
- If the product has been exposed to rain or water.
- If the product does not operate normally when the operating instructions are followed. Adjust only those controls that are covered by the operating instructions. Improper adjustment of other controls may result in damage and can require extensive work by a qualified technician to restore the unit to its normal operation.
- When the product exhibits a distinct change in performance – this indicates a need for service.

Check that there are no irregularities with the AC adapter or power plug, then insert the power plug into the specified position of the AC adapter

using the specified procedure until a click is heard. For details, see *Mounting the power plug* on page 18.

If there are irregularities with the AC adapter or power plug, ask your nearest Pioneer authorized service center or your dealer to carry out repair work.

- Do not use this unit with a coin, paper clip or other metal object stuck between the AC adapter and power plug. Doing so could cause a short circuit, leading to fire or electric shock.

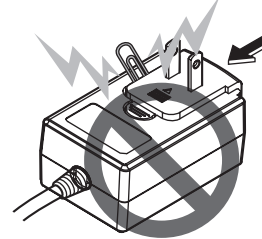

- When mounting the AC adapter on a wall outlet, make sure there is no space between the AC adapter and the wall outlet. Faulty contact or a coin, paper clip or other metal object getting stuck in the space could cause a short circuit, leading to fire or electric shock.

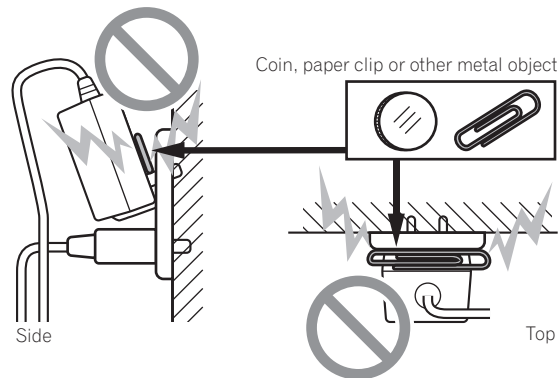

- The power plug could come detached from the AC adapter and remain in the power outlet if someone trips on the AC adapter's power cord or if something hits the AC adapter. If this happens, remove the power plug remaining in the outlet with dry hands, holding it as shown on the diagram below and without touching metal parts. Do not use any tools to remove it.

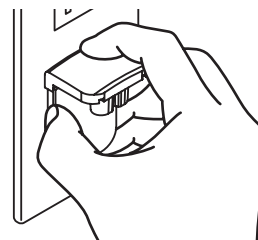

Mounting the power plug

Slide the power plug along the guide rails in the AC adapter unit as shown on the diagram below, then press in until a click is heard.

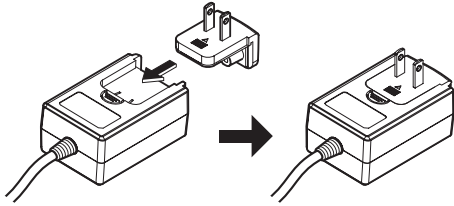

Removing the power plug

While pressing the [PUSH] button on the AC adapter unit, slide the power plug away from the adapter as shown on the diagram below to remove it.

Once the power plug is mounted, there is no need to remove it.

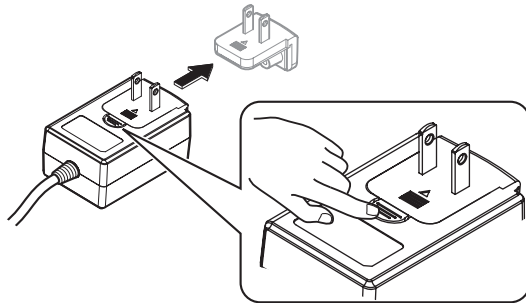

Power plug

The power plug shown below is included with this product.

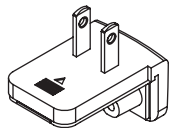

Additional information

Troubleshooting

- Incorrect operation is often mistaken for trouble or malfunction. If you think that there is something wrong with this component, check the points below. Sometimes the trouble may lie in another component. Inspect the other components and electrical appliances being used. If the trouble cannot be rectified after checking the items below, ask your nearest Pioneer authorized service center or your dealer to carry out repair work.
- This unit may not operate properly due to static electricity or other external influences. In this case, proper operation may be restored by turning the power off, waiting 1 minute, then turning the power back on.

Problem	Check	Remedy
The power is not turned on.	Is the [STANDBY/ON] switch for power supply set to [ON] ?	Set the [STANDBY/ON] switch for power supply to [ON] .
	Is the included AC adapter properly connected?	Mount the power plug properly on the included AC adapter. (page 18) Connect the included AC adapter properly to the power outlet. (page 18) Connect the included AC adapter's DC plug properly to this unit.
This unit is not recognized.	Is the included USB cable properly connected?	Connect the included USB cable properly.
	Are you using a USB hub?	USB hubs cannot be used. Connect the computer and this unit directly using the included USB cable.
	Is the driver software properly set?	Set the driver software properly. (page 6)
Tracks are not displayed in the library.	Have music files been imported?	Import the music files properly. For details on importing music files, see the "Serato DJ software manual".
	Is a crate or subcrate that does not contain any tracks selected?	Either select a crate or subcrate that contains any tracks or add tracks to the crate or subcrate.
iTunes tracks are not displayed in the library.	Is [Show iTunes Library] at the [Show iTunes Library] tab in the [SETUP] menu checked?	Check [Show iTunes Library] at the [Show iTunes Library] tab in the [SETUP] menu. For details on importing music files, see the "Serato DJ software manual".
	Is a crate or subcrate that does not contain any tracks selected?	Either select a crate or subcrate that contains any tracks or add tracks to the crate or subcrate.
Music files in the library cannot be edited (changing track names, etc.).	Is [Protect Library] in [SETUP] enabled?	Disable [Protect Library] .
Recording is not possible.	Is the recording level low?	Adjust the gain control on the [Record] panel in the Serato DJ software.
	Have you saved the recording after completing it?	Save the recording after completing it. For detailed instructions on recording, see the "Serato DJ software manual".
No sound or small sound.	Are the [TRIM] control, channel faders, crossfader and [MASTER LEVEL] control set to the proper positions?	Set the [TRIM] , [channel fader], [crossfader] and [MASTER LEVEL] controls to the proper positions.
	Are the connected powered speakers, etc., properly set?	Properly set the external input selection, volume, etc., on the powered speakers, etc.
	Are the connection cables properly connected?	Connect the connection cables properly.
	Are the terminals and plugs dirty?	Clean the terminals and plugs before making connections.
	Is the driver software properly set?	Set the driver software properly. (page 6)
Distorted sound.	Is the [MASTER LEVEL] control set to the proper position?	Adjust the [MASTER LEVEL] control so that the master level indicator's orange indicator lights at the peak level.
	Is the [TRIM] control set to the proper position?	Adjust the [TRIM] control so that the channel level indicator's orange indicator lights at the peak level.
	Is [HEADROOM] in the [SETUP] menu properly set?	Set the level properly.
Sound being played is interrupted when using DJ software.	Is the driver software's latency value suitable?	Set the driver software's latency to a suitable value.
	Is the [INPUT SELECT] switch set to the proper position?	Set the [INPUT SELECT] switch to the proper position.
Sound of an external device or microphone cannot be output.	Is the [INPUT SELECT] switch set to the proper position?	Set the [INPUT SELECT] switch to the proper position.
Sound is interrupted when the ASIO driver is set.	Has the ASIO driver been set with Serato DJ running?	Set the ASIO driver before launching Serato DJ. (page 6)
The indicator flashes and operation is strange.	—	Normal operation can be restored by disconnecting the AC adapter, waiting at least 1 minute, then reconnecting the AC adapter. If the same symptom persists, disconnect the AC adapter, then request repairs.

Problem	Check	Remedy
Serato DJ operation is unstable.	Are you using the latest version of the software?	Free updates of Serato DJ can be downloaded from the Internet. Check the website below and keep the software updated to the latest version. (page 6)
	Are you using softwares other than Serato DJ at the same time?	Quit other applications to decrease the load on the computer. (page 6) If operation continues to be unstable, try disabling the wireless network or other wireless connections, antivirus software, the screen saver, the low power mode, etc. (page 6)
	When other USB devices are connected to the computer.	Disconnect other USB devices from the computer. When another USB audio device is connected to the computer at the same time, it may not operate or be recognized normally.
	Are you using a USB hub?	USB hubs cannot be used. Connect the computer and this unit directly using the included USB cable.
	There is a problem with the USB port to which this unit is connected.	If your computer has multiple USB ports, try connecting this unit to a different USB port.
	Is this unit connected to a notebook computer running on its battery?	Supply power to the notebook computer from an AC power supply. (Depending on the notebook computer's settings, the low power mode may be set when the computer is running on its battery, automatically reducing the performance of the computer itself.) (page 6)
	The USB buffer size is too small.	Raise the USB buffer size.

About trademarks and registered trademarks

- Pioneer is a registered trademark of PIONEER CORPORATION. The names of companies and products mentioned herein are the trademarks of their respective owners.

Cautions on copyrights

Recordings you have made are for your personal enjoyment and according to copyright laws may not be used without the consent of the copyright holder.

- Music recorded from CDs, etc., is protected by the copyright laws of individual countries and by international treaties. It is the full responsibility of the person who has recorded the music to ensure that it is used legally.
- When handling music downloaded from the Internet, etc., it is the full responsibility of the person who has downloaded the music to ensure that it is used in accordance with the contract concluded with the download site.

Specifications

AC adapter

Power requirements	AC 120 V, 60 Hz
Rated current	800 mA
Rated output	DC 5 V, 3 A

General – Main Unit

Main unit weight	5.8 kg (13 lb)
Max. dimensions	664 mm (W) × 70.4 mm (H) × 357 mm (D) (26.1 in. (W) × 2.8 in. (H) × 14.1 in. (D))
Tolerable operating temperature	+5 °C to +35 °C (+41 °F to +95 °F)
Tolerable operating humidity	5 % to 85 % (no condensation)

Audio Section

Sampling rate	44.1 kHz
A/D, D/A converter	24 bits
Frequency characteristic	
USB, LINE, MIC	20 Hz to 20 kHz
S/N ratio (rated output, A-WEIGHTED)	
USB	105 dB
LINE	95 dB
PHONO	92 dB
MIC	92 dB
Total harmonic distortion (20 Hz — 20 kHzBW)	
USB	0.003 %

LINE	0.005 %
Standard input level / Input impedance	
LINE	-12 dBu/47 kΩ
PHONO	-48 dBu/47 kΩ
MIC	-52 dBu/10 kΩ
Standard output level / Load impedance / Output impedance	
MASTER OUT 1	+8 dBu/10 kΩ/330 Ω
MASTER OUT 2	+2 dBu/10 kΩ/1 kΩ
BOOTH	+8 dBu/10 kΩ/330 Ω
PHONE	+4 dBu/32 Ω/32 Ω
Rated output level / Load impedance	
MASTER OUT 1	26 dBu/10 kΩ
MASTER OUT 2	20 dBu/10 kΩ
BOOTH	26 dBu/10 kΩ
Crosstalk	
LINE	87 dB
Channel equalizer characteristic	
HI	-26 dB to +6 dB (13 kHz)
MID	-26 dB to +6 dB (1 kHz)
LOW	-26 dB to +6 dB (70 kHz)

Input / Output terminals

CD input terminal	
RCA pin jack	2 sets
PHONO/LINE input terminals	
RCA pin jack	2 sets
MIC1 terminal	
XLR connector/phone jack (Ø 6.3 mm)	1 set
MIC2 terminal	
Phone jack (Ø 6.3 mm)	1 set
MASTER OUT 1 output terminal	
XLR connector	1 set
MASTER OUT 2 output terminal	
RCA pin jacks	1 set
BOOTH output terminal	
Phone jack (Ø 6.3 mm)	1 set
PHONES output terminal	
Stereo phone jack (Ø 6.3 mm)	1 set
Stereo mini phone jack (Ø 3.5 mm)	1 set
USB terminal	
B type	1 set
• For improvement purposes, specifications and design of this unit and the included software are subject to change without notice.	



PIONEER ELECTRONICS (USA) INC.
LIMITED WARRANTY
 WARRANTY VALID ONLY IN THE U.S.A. AND CANADA

WARRANTY

Pioneer Electronics (USA) Inc. (PUSA) warrants that products distributed by PUSA in the U.S.A. and Canada that fail to function properly under normal use due to a manufacturing defect when installed and operated according to the owner's manual enclosed with the unit will be repaired or replaced with a unit of comparable value, at the option of PUSA, without charge to you for parts or actual repair work. Parts supplied under this warranty may be new or rebuilt at the option of PUSA.

THIS LIMITED WARRANTY APPLIES TO THE ORIGINAL OR ANY SUBSEQUENT OWNER OF THIS PIONEER PRODUCT DURING THE WARRANTY PERIOD PROVIDED THE PRODUCT WAS PURCHASED FROM AN AUTHORIZED PIONEER DISTRIBUTOR/DEALER IN THE U.S.A. OR CANADA. YOU WILL BE REQUIRED TO PROVIDE A SALES RECEIPT OR OTHER VALID PROOF OF PURCHASE SHOWING THE DATE OF ORIGINAL PURCHASE OR, IF RENTED, YOUR RENTAL CONTRACT SHOWING THE PLACE AND DATE OF FIRST RENTAL. IN THE EVENT SERVICE IS REQUIRED, THE PRODUCT MUST BE DELIVERED WITHIN THE WARRANTY PERIOD, TRANSPORTATION PREPAID, ONLY FROM WITHIN THE U.S.A. AS EXPLAINED IN THIS DOCUMENT. YOU WILL BE RESPONSIBLE FOR REMOVAL AND INSTALLATION OF THE PRODUCT. PUSA WILL PAY TO RETURN THE REPAIRED OR REPLACEMENT PRODUCT TO YOU WITHIN THE U.S.A.

PRODUCT WARRANTY PERIOD

	<u>Parts</u>	<u>Labor</u>
DJ Audio and Video	1 Year	1 Year

The warranty period for retail customers who rent the product commences upon the date product is first put into use (a) during the rental period or (b) retail sale, whichever occurs first.

WHAT IS NOT COVERED

IF THIS PRODUCT WAS PURCHASED FROM AN UNAUTHORIZED DISTRIBUTOR, THERE ARE NO WARRANTIES, EXPRESS OR IMPLIED, INCLUDING THE IMPLIED WARRANTY OF MERCHANTABILITY AND THE IMPLIED WARRANTY OF FITNESS FOR A PARTICULAR PURPOSE AND THIS PRODUCT IS SOLD STRICTLY "AS IS" AND "WITH ALL FAULTS".

PIONEER SHALL NOT BE LIABLE FOR ANY CONSEQUENTIAL AND/OR INCIDENTAL DAMAGES.

THIS WARRANTY DOES NOT APPLY IF THE PRODUCT HAS BEEN SUBJECTED TO POWER IN EXCESS OF ITS PUBLISHED POWER RATING.

THIS WARRANTY DOES NOT COVER THE CABINET OR ANY APPEARANCE ITEM, USER ATTACHED ANTENNA, ANY DAMAGE TO RECORDS OR RECORDING TAPES OR DISCS, ANY DAMAGE TO THE PRODUCT RESULTING FROM ALTERATIONS, MODIFICATIONS NOT AUTHORIZED IN WRITING BY PIONEER, ACCIDENT, MISUSE OR ABUSE, DAMAGE DUE TO LIGHTNING OR TO POWER SURGES, SUBSEQUENT DAMAGE FROM LEAKING, DAMAGE FROM INOPERATIVE BATTERIES, OR THE USE OF BATTERIES NOT CONFORMING TO THOSE SPECIFIED IN THE OWNER'S MANUAL.

THIS WARRANTY DOES NOT COVER THE COST OF PARTS OR LABOR WHICH WOULD BE OTHERWISE PROVIDED WITHOUT CHARGE UNDER THIS WARRANTY OBTAINED FROM ANY SOURCE OTHER THAN A PIONEER AUTHORIZED SERVICE COMPANY OR OTHER DESIGNATED LOCATION. THIS WARRANTY DOES NOT COVER DEFECTS OR DAMAGE CAUSED BY THE USE OF UNAUTHORIZED PARTS OR LABOR OR FROM IMPROPER MAINTENANCE.

ALTERED, DEFACED, OR REMOVED SERIAL NUMBERS VOID THIS ENTIRE WARRANTY

NO OTHER WARRANTIES

PIONEER LIMITS ITS OBLIGATIONS UNDER ANY IMPLIED WARRANTIES INCLUDING, BUT NOT LIMITED TO, THE IMPLIED WARRANTIES OF MERCHANTABILITY AND FITNESS FOR A PARTICULAR PURPOSE, TO A PERIOD NOT TO EXCEED THE WARRANTY PERIOD. NO WARRANTIES SHALL APPLY AFTER THE WARRANTY PERIOD. SOME STATES DO NOT ALLOW LIMITATIONS ON HOW LONG AN IMPLIED WARRANTY LASTS AND SOME STATES DO NOT ALLOW THE EXCLUSIONS OR LIMITATIONS OF INCIDENTAL OR CONSEQUENTIAL DAMAGES, SO THE ABOVE LIMITATIONS OR EXCLUSIONS MAY NOT APPLY TO YOU. THIS WARRANTY GIVES YOU SPECIFIC LEGAL RIGHTS AND YOU MAY HAVE OTHER RIGHTS WHICH MAY VARY FROM STATE TO STATE.

TO OBTAIN SERVICE

PUSA has appointed a number of Authorized Service Companies throughout the U.S.A. and Canada should your product require service. To receive warranty service you need to present your sales receipt or, if rented, your rental contract showing place and date of original owner's transaction. If shipping the unit you will need to package it carefully and send it, transportation prepaid by a traceable, insured method, to an Authorized Service Company. Package the product using adequate padding material to prevent damage in transit. The original container is ideal for this purpose. Include your name, address and telephone number where you can be reached during business hours.

On all complaints and concerns in the U.S.A. and Canada call Customer Support at 1-800-872-4159.

For hook-up and operation of your unit or to locate an Authorized Service Company, please call or write:
 CUSTOMER SUPPORT
 PIONEER ELECTRONICS (USA) INC.
 P.O. BOX 1720
 LONG BEACH, CALIFORNIA 90801
 1-800-872-4159
<http://www.pioneerelectronics.com>

DISPUTE RESOLUTION

Following our response to any initial request to Customer Support, should a dispute arise between you and Pioneer, Pioneer makes available its Complaint Resolution Program to resolve the dispute. The Complaint Resolution Program is available to you without charge. You are required to use the Complaint Resolution Program before you exercise any rights under, or seek any remedies, created by Title I of the Magnuson-Moss Warranty-Federal Trade Commission Improvement Act, 15 U.S.C.2301 et seq.

To use the Complaint Resolution Program call 1-800-872-4159 and explain to the customer service representative the problem you are experiencing, steps you have taken to have the product repaired during the warranty period and the name of the authorized Distributor/Dealer from whom the Pioneer product was purchased. After the complaint has been explained to the representative, a resolution number will be issued. Within 40 days of receiving your complaint, Pioneer will investigate the dispute and will either: (1) respond to your complaint in writing informing you what action Pioneer will take, and in what time period, to resolve the dispute; or (2) respond to your complaint in writing informing you why it will not take any action.

RECORD THE PLACE AND DATE OF PURCHASE FOR FUTURE REFERENCE

Model No. _____ Serial No. _____ Purchase Date _____

Purchased From _____

KEEP THIS INFORMATION AND YOUR SALES RECEIPT IN A SAFE PLACE

UCP0212

Additional information

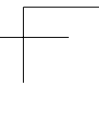
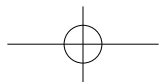
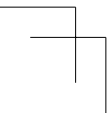
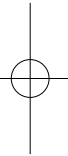
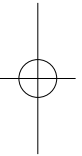
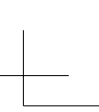
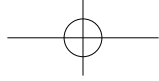
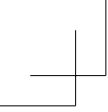

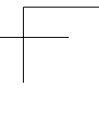
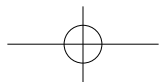
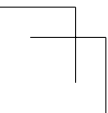
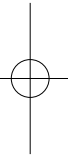
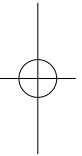
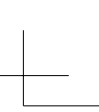
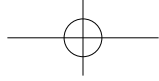
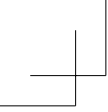

To register your product, find the nearest authorized service location, to purchase replacement parts, operating instructions, or accessories, please go to one of following URLs :

Pour enregistrer votre produit, trouver le service après-vente agréé le plus proche et pour acheter des pièces de rechange, des modes d'emploi ou des accessoires, reportez-vous aux URL suivantes :

In the USA & Canada/Aux Etats-Unis & Canada
<http://www.pioneerelectronics.com>

S018_B1_EnFr_PSV

© 2012 PIONEER CORPORATION.
All rights reserved.

PIONEER CORPORATION

1-1, Shin-ogura, Saiwai-ku, Kawasaki-shi, Kanagawa 212-0031, Japan

PIONEER ELECTRONICS (USA) INC.

P.O. BOX 1720, Long Beach, California 90801-1720, U.S.A. TEL: (800) 421-1404

K002_PSV_CU

Printed in China

<DRH1192-A>
<502-DDSXA-3277>